

TEAC

SERVICE MANUAL

GF-450K7

Micro Hi-Fi system



NOTES

- PC board shown are viewed from parts side.
- The parts with no reference number or no parts number in the exploded views are not supplied.
- As regards the resistors and capacitors, refer to the circuit diagrams contained in this manual.
- ⚠ Parts marked with this sign are safety critical components. they must be replaced with identical components - refer to the appropriate parts list and ensure exact replacement.
- Parts of [] mark can be used only with the version designated.

[USA] - U.S.A.; [JPN] - Japan

CONTENTS

1 SAFETY INFORMATION	2
2 SPECIFICATIONS	3
3 ADJUSTMENT AND CHECK	4
4 EXPLODED VIEW AND PARTS LIST	8
5 PC BOARDS AND PARTS LIST	12
6 WIRING DIAGRAM	18
7 INCLUDED ACCESSORIES	21

GF-450K7

1 SAFETY INFORMATION

SAFETY INFORMATION

This product has been designed and manufactured according to FDA regulations "title 21, CFR, chapter 1, subchapter J, based on The Radiation Control for Health and Safety Act of 1968" and is classified as class 1 laser product. There is not hazardous invisible laser radiation during operation because invisible laser radiation emitted inside of this product is completely confined in the protective housings. The label required in this regulation is shown ①.

• CAUTION

USE OF CONTROLS OR ADJUSTMENT OR PERFORMANCE OF PROCEDURES OTHER THAN THOSE SPECIFIED HEREIN MAY RESULT IN HAZARDOUS RADIATION EXPOSURE.

DO NOT REMOVE THE PROTECTIVE HOUSING USING SCREWDRIVER.

IF THIS PRODUCT DEVELOPS TROUBLE, MAKE A CONTACT WITH OUR SERVICEMAN, AND DO NOT USE THE PRODUCT A TROUBLED STATE.

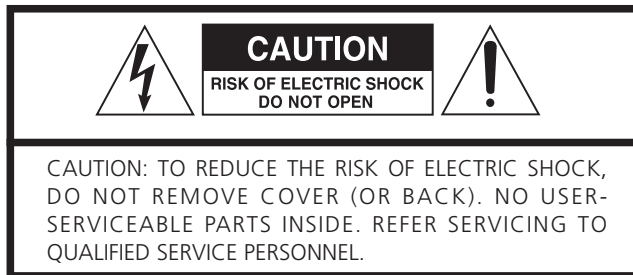
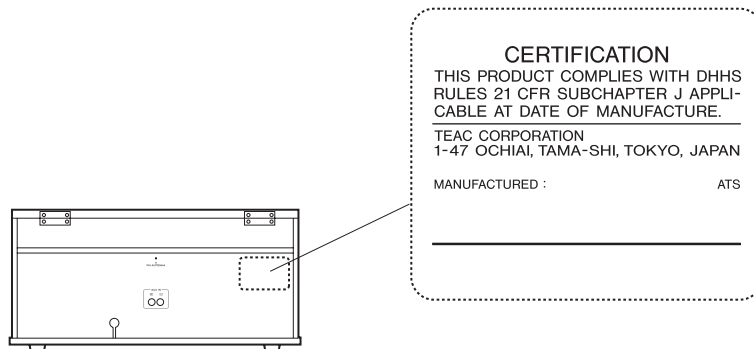

The lightning flash with arrowhead symbol, within an equilateral triangle, is intended to alert the user to the presence of uninsulated "dangerous voltage" within the product's enclosure that may be of sufficient magnitude to constitute a risk of electric shock to persons.



The exclamation point within an equilateral triangle is intended to alert the user to the presence of important operating and maintenance (servicing) instructions in the literature accompanying the appliance.

Optical pickup:	
Type	: SF-W37SGT
Manufacturer	: SANYO ELECTRIC CO., LTD.
Laser output	: Less than 1 mW (Play) on the objective lens
	: Less than 5 mW (Record) on the objective lens
	: Less than 10 mW (Erase) on the objective lens
Wavelength	: 783 nm

2 SPECIFICATIONS

Amplifier Section

Output power	3.5 W + 3.5 W
Frequency response	60 Hz to 20 kHz
Audio input sensitivity/Impedance	AUX: -6dBV(0.5V)/20kΩ
Maximum iutput level	AUX:+6dBV(2.0V)

CD Recorder Section

Media type (record and playback), CD (playback only)	CD-RW and CD-R for Digital audio
Recording sampling frequency	44.1kHz
Frequency response (playback:±2dB, recording:±3dB)	20Hz to 20kHz
Signal to noise ratio	More than 90dB (playback)
More than 80dB (recording)	
Total harmonic distortion	Less than 0.05% (playback)
Less than 0.07% (recording)	

Tuner Section

Frequency range(FM)	87.5MHz to 108.0 MHz (100 kHz step) [USA]
Frequency range(AM)	530 kHz to 1,720 kHz (10 kHz step)
Frequency range(FM)	76.0 MHz to 90.0 MHz (100 kHz step) [JPN]
Frequency range(AM)	522 kHz to 1,620 kHz (9 kHz step)

Record Player Section

Motor	DC servo motor
Drive system	Belt Drive
Speed	33-1/3 rpm, 45 rpm, 78 rpm
Wow and Flutter	less than 0.35% (WDT)
Cartridge type	Ceramic Stereo Cartridge
Stylus	STL-103
Output level	158 -348mV

Cassette tape section

Tracking system	4-track, 2-channel stereo
Tape speed	4.8 cm/sec
Wow&flutter	0.3%
Frequency characteristic	125 to 10,000 Hz
S/N ratio	45 dB

Speaker System Section

Unit	70 mm (3")
Impedance	4 ohms

GENERAL

Power requirements	120V, 60Hz [USA]
Power requirements	100V, 50~60Hz [JPN]
Power consumption	55 W
Dimensions (W x H x D) (18 7/8" x 9 1/16" x 14 15/16")	480 x 230 x 380 mm
Weight	11 kg (24 1/4 lb)

Standard Accessories

Owner's manual x 1
Warranty card x 1
45 RPM adaptor x 1
Remote control unit (RC-992) x 1 [USA]
Remote control unit (RC-1069) x 1 [JPN]
Battery (AA, R6, SUM-3) x 2
Quick Start Guide for recording x 1
Stereo RCA pin cable x 1

- Design and specifications are subject to change without notice.
- Weight and dimensions are approximate.
- Illustrations may differ slightly from production models.

GF-450K7

3 ADJUSTMENTS AND CHECKS

ALIGNMENT PROCEDURES

3-1 TUNER SECTION

Use a screwdriver with a plastic or ceramic grip for all adjustment.

3-1-1 FM adjustment

1. Set the function switch to the FM position.
2. Connect the signal generator output through a 75 ohm dummy antenna to "ANT" on MAIN PCB.
3. Connect the oscilloscope to the speaker terminal.
4. Set the signal generator as listed in the alignment chart.

3-1-2 AM adjustment

1. Set the function switch to the AM position.
2. Connect the test loop antenna across the output of the signal generator.
3. Connect the oscilloscope to the speaker terminal.
4. Set the signal generator as listed in the alignment chart.

3-1-3 Turntable Section

1. Set the function switch to the PHONE position.
2. Connect the oscilloscope to the speaker terminal.
3. Use a HP-4005 record for all adjustment.

3-2 Adjustment and Test Points

120 V UL model Tuner adjustments AM

ITEM		Spec.	Limit	1	2	3	UNIT
01. Tuning Range	Low End	525	+/-10				KHz
	High End	1730	+/-30				KHz
02. I.F		455	+/-5				KHz
03. MAX. Sens.	600 KHz	52	58				dBuv/m
	1000 KHz	52	58				dBuv/m
	1400 KHz	52	58				dBuv/m
04. Sen. For -20db S/N	600 KHz	58	64				dBuv/m
	1000 KHz	56	64				dBuv/m
	1400 KHz	56	64				dBuv/m
05. I.F.Rejection(Max.Sens)	at 600 KHz	35	30				db
06. Image Rejection(5mV)	at 1400 KHz	30	25				db
07. Tweet at 5mV/m	2 x 1.F.	5	15				%
	3 x 1.F.	/	/				%
08. A.C.A.+/-10 KHz	at 1000 KHz	20	15				db
09. Band Width -6db at 10% 1000khz Max Sens		5	4-9				KHz
10. A.G.C.(-10db) at 1000KHz 100db/m		35	30				db
11.T.H.D. 74db/m 30%MOD		2	5				%
12. Power Output at 10% THD 80%74db/m		3.6	3.5				W
13. Freq. Resp. -Low		100	125				Hz
	-6 db High	2.2	2				KHz
14. Hum & Noise (Min Volume)		3	10				MV
15. HUM Modulation 100db/m		40	35				db
REMARKS:		TEST BY :		APPROVED:			

120 V UL model Tuner adjustments FM

ITEM		Spec.	Limit	1	2	3	UNIT
01. Tuning Range	Low End	87.5	+/-0.5				MHz
	High End	108.5	+/-0.5				MHz
02. Intermediate Frequency		10.7	+/-0.2				KHz
03.MAX. Sens.	90 MHz	13	20				db
	98 MHz	13	20				db
	106 MHz	13	20				db
04. Sen. For -30db S/N	90 MHz	20	26				db
	98 MHz	20	26				db
	106 MHz	20	26				db
05. I.F.Rejection		40	38				db
06.Image Rejection	at 106MHz	20	18				db
07.-3db limiting Sens . at98MHz 1mV		25	15				db
08. A.M.Suppression at 98MHz 1mV		30	25				db
09. A.F.C Holding at 98MHz 1mV		300	+/-250				KHz
10.S/N Ratio at 98MHz 1mV		45	40				db
11.T.H.D. 22.5KHz DEV.		1	2				%
12. Power Output at 10% THD 75KHz DEV 1mv		3.6	3.5				W
Max. v olume T.H.D		10	30				%
13. Ferq. Resp. -6db -Low		50	150				Hz
High		4.5	4				KHz
14. HUM & NOISE (Min. Volume)		1	5				MV
							db
Multiplex:							
01.Stereo Indication Sens.at 98Mhz 75KHz Dev.1KHz		18	25				db
02.Separation at 98 MHz 1mV 40KHz Dev.		30	26				db
03. Channel Balance		1	3				db
04. Stereo Distortion at 98MHz 1mV 45KHz Dev.		3	4				db
REMARKS		TEST BY :			APPROVED:		

GF-450K7

100 V JPN model Tuner adjustments

AM I.F. ALIGNMENT

1. Set the POWER BUTTON to POWER "ON".
2. Set the Radio and band button to Radio and AM BAND.
3. Connect a SWEEPSCOPE OUTPUT to AM antenna terminal.
4. Connect a SWEEPSCOPE INPUT to pin17 of IC2 through a 1uf capacitor and ground.

STEP	SET SIGNAL	SET DIAL	ADJUST	ADJUST FOR
1	4455KHz	GANG OPEN	T3	CENTER &MAXIMUM OUTPUT

AM R.F. ALIGNMENT

1. Connect an RF generator to a standard radiating loop.
2. Connect a SCOPE and VTVM across the speaker output.

STEP	SET SIGNAL	SET DIAL	ADJUST	ADJUST FOR
1	515KHz	GANG CLOSED	L6	MAXIMUM OUTPUT
2	1640KHz	GANG OPEN	PVC-D	
3	600KHz	1400KHz	L4	
4	1400KHz	1400KHz	PVC-C	
5	REPEAT STEPS 3 AND 4 TO OBTAIN BEST TRACKING.			

FM R.F. ALIGNMENT

1. Connect an RF generator to the FM antenna terminal and ground.
2. Connect a SCOPE & VTVM across the speaker output.

STEP	SET SIGNAL	SET DIAL	ADJUST	ADJUST FOR
1	76MHz	GANG CLOSED	L3	MAXIMUM OUTPUT
2	108MHz	GANG OPEN	PVC-A	
3	90MHz	90MHz	L2	
4	106MHz	1106MHz	PVC-B	
5	REPEAT STEPS 3 AND 4 TO OBTAIN MAX ADJUST.			

MAIN PCB

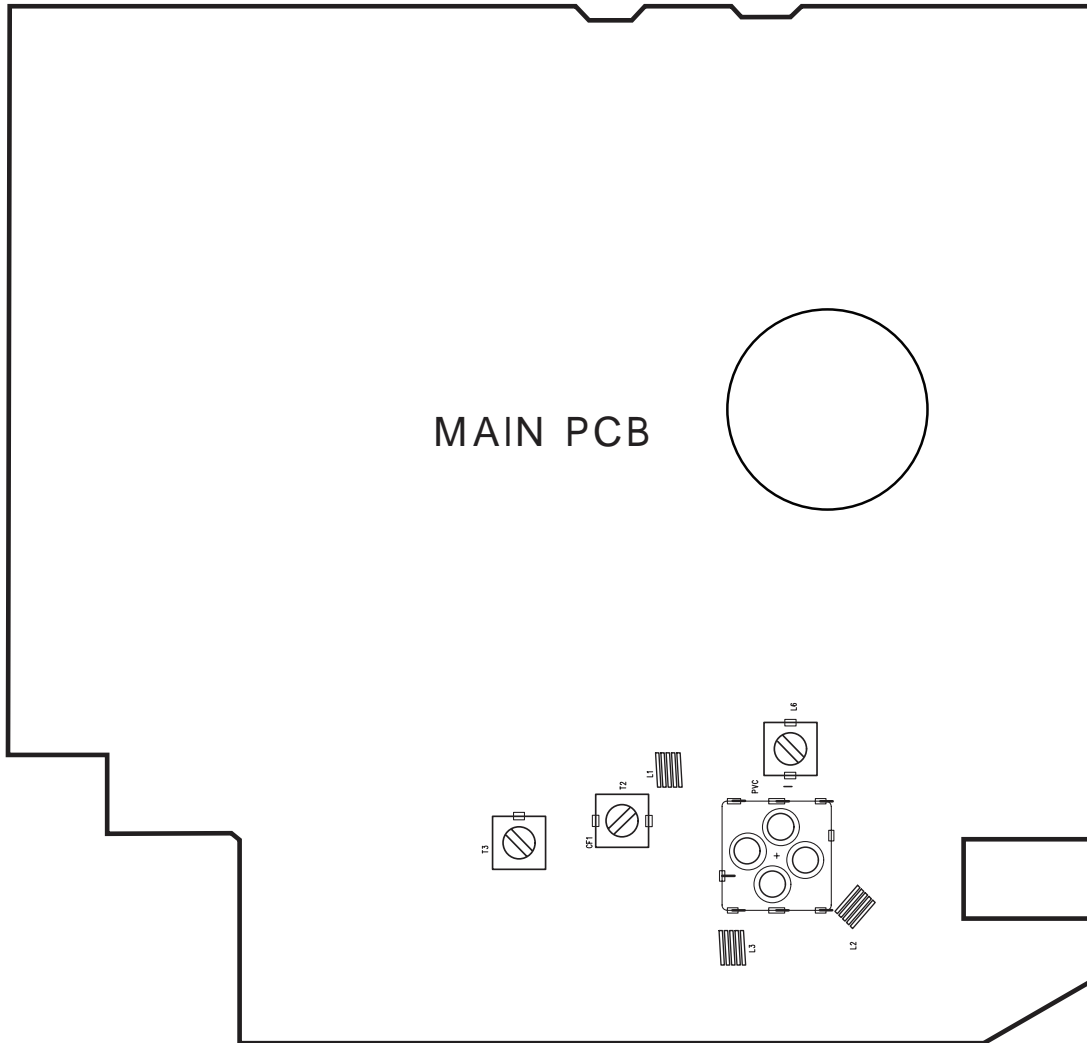

GF-450K7

4 EXPLODED VIEWS AND PARTS LIST

EXPLODE VIEW

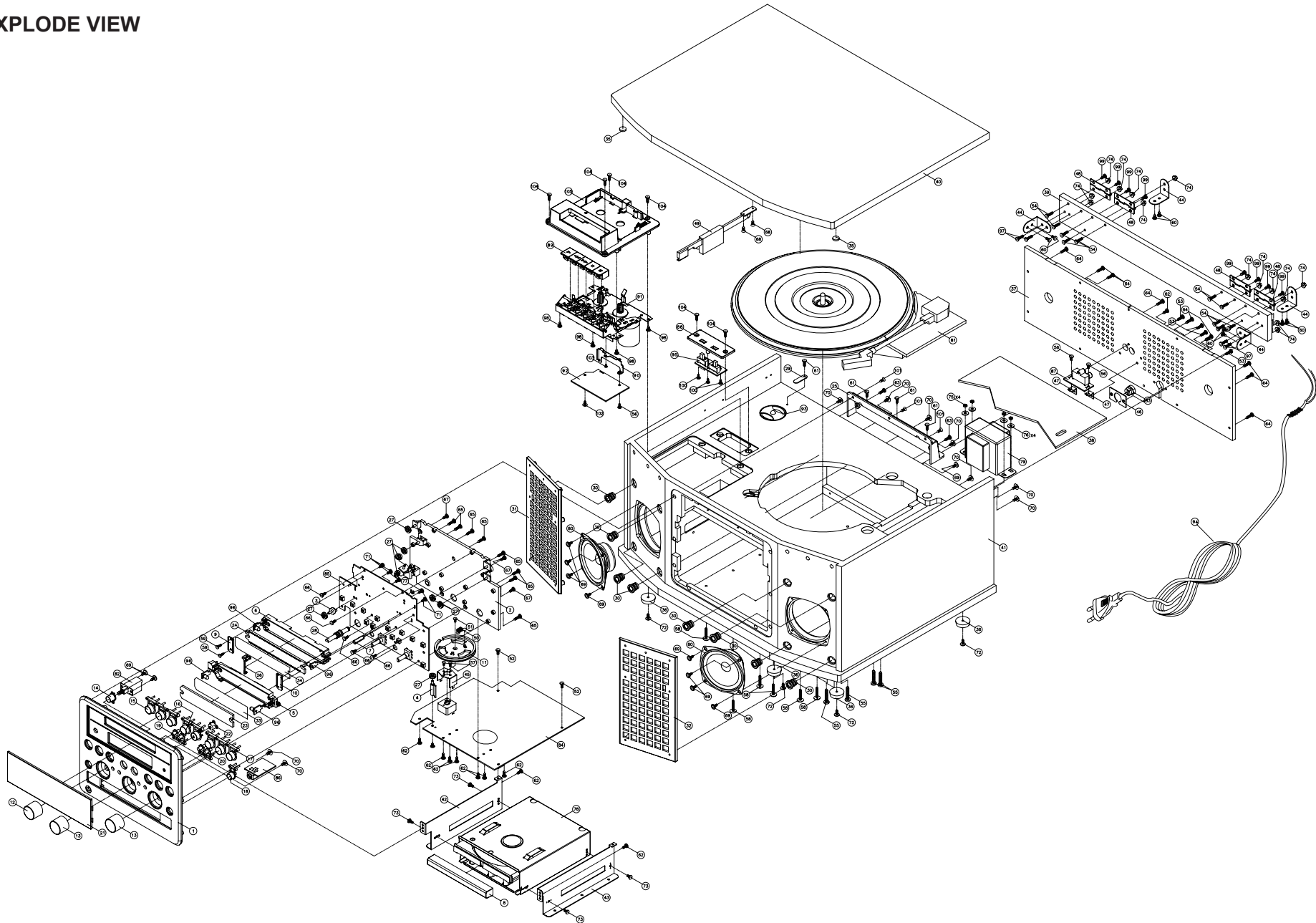

EXPLODED VIEW

REF. NO.	PARTS NO.	DESCRIPTION	REMARKS
1	56-04GF3500B050	FRONT PANEL (HIPS) JAPAN BLACK [JPN]	
	56-04GF3500B030	FRONT PANEL (HIPS) JAPAN BLACK [USA]	
2	56-07GF3500B000	DIAL BRACKET (ABS)	
3	56-07GF3501B000	PULLEY BKT (1) (ABS)	
4	56-07GF3502B000	PULLEY BKT (2) (ABS)	
5	56-07GF35039000	DISPLAY BACKET HOLDER (ABS)	
6	56-07GF35049000	TUNING BACKLIGHT HOLDER (ABS)	
7	56-07GF3505B000	LIGHT BKT (ABS)	
8	56-14GF3500B010	CD DOOR (ABS) (BLACK 931289) 429C	
9	56-22GF35008010	DIAL BACK LIGHT LENS COVER-L (ABS) (gray 91144)	
10	56-22GF35018010	DIAL BACK LIGHT LENS COVER-R (ABS) (gray 91144)	
11	56-25GF3500B000	DIAL DRUM (ABS)	
12	56-54GF35008000	TUNING KNOB (ABS) (gray8402C)	
13	56-54GF35018000	VOLUME/REC. LEVEL KNOB (ABS) (gray8402C)	
14	56-54GF3502B000	POWER SWITCH KNOB (ABS) (BLACK 931289)	
15	56-54GF3503B000	FUNCTION KNOB (ABS) (BLACK 931289)	
16	56-54GF3504B000	RECORD KNOB (ABS) (BLACK 931289)	
17	56-54GF3505B010	STOP/PLAY/PAUSE KNOB (ABS) (BLACK 931289)	
18	56-54GF3506B010	OPEN/CLOSE KNOB (ABS) (BLACK 931289)	
19	56-54GF3507B000	DELETE KNOB (ABS) (BLACK 931289)	
20	56-54GF3508B000	SKIP/REW KNOB (ABS) (BLACK 931289)	
21	56-57GF35000030	DISPLAY LENS (PMMA) TEAC [JPN]	
	56-57GF35000040	DISPLAY LENS (PMMA) [USA]	
22	56-57GF35019000	REC KNOB LENS (PMMA)	
23	56-57GF35020000	LCD BACKLIGHT LENS (PMMA)	
24	56-57GF35030010	TUNING BACKLIGHT LENS (PMMA)	
25	56-69GF3500B000	WOODEN BOX COVER PLATE (ABS) (BLACK 931289)	
26	56-75GF3500G000	POINT (ABS) (CHROME)	
27	56-76ST1500B000	DIAL PULLEY (POM)	
28	56-79GF3500B000	TUNING SHAFT (ABS)	
29	57-08ST15000120	PVC PLATE 22x8x1mm (BLACK)	
30	56-80S16800B000	SPEAKER PANEL STUD (PE) BLACK	
31	56-86GF3500B000	SPEAKER FRAME-L (HIPS)	
32	56-86GF3501B000	SPEAKER FRAME-R (HIPS)	
33	57-26GF35000020	FILTER PLATE (1) 114x22.6x0.1mm	
34	57-26GF35000120	FILTER PLATE (2) 118.1x20.8x0.3mm	
35	58-263102200020	RUBBER FOOT (PORON) DIA10mm T=2mm	
36	58-263182600020	RUBBER FOOT DIA18 T=6mm (AC619)	
37	58-70GF35000420	REAR BOARD 100V "TEAC GF-450-K7" [JPN]	
	58-70GF35000621	REAR BOARD 120V "TEAC GF-450-K7" R1 [USA]	
38	58-71GF35000220	WOODEN PLATE 230x292x3mm	
39	58-71GF35000420	WOODEN BOARD 449.6x58x9mm (BLACK) "GF450-K7"	
40	58-71GF35000520	WOODEN TOP COVER (BLACK) "GF450-K7"	
41	58-73GF35000220	WOODEN BOX (PVC: F-2905-53) "GF450-K7"	
42	61-11GF35000021	CD MACHINE BRACKET (L)	
43	61-11GF35000120	CD MACHINE BRACKET (R)	
44	61-11GF35000221	WOODEN BRACKET R1	
45	61-11SN11600021	PVC BRACKET	
46	61-22SG19000020	BUSHING MOUNTING PLATE	
47	61-25SCD6600020	CONTACT PLATE (THK 1.2mm) 11x11x8mm	
48	61-57GF35000020	LOOSE LEAF	
49	61-57GF35000120	WOODEN BOX OPEN/CLOSE SHAFT	
50	61-95T060800020	SPRING DIAL	
51	66-120226150321	MACHINE SCREW RoHS MS/BH 2.6x5mm	
52	66-120230180321	MACHINE SCREW RoHS MS/BH 3x8mm	

GF-450K7

EXPLODED VIEW

REF. NO.	PARTS NO.	DESCRIPTION	REMARKS
53	66-120230210321	MACHINE SCREW RoHS MS/BH 3x10mm	
54	66-120930214121	MACHINE SCREW RoHS MS/CH 3x14mm (BLACK)	
55	66-120240222321	MACHINE SCREW RoHS MS/BH 4x22mm	
56	66-120330160321	MACHINE SCREW RoHS MS/PH 3x6mm	
57	66-120526140321	MACHINE SCREW RoHS MS/KH 2.6x4mm (H:4mm)	
58	66-120830220321	MACHINE SCREW RoHS MS/WH 3x20mm	
59	66-140226180321	SELF-TAPPING SCREW RoHS TA/BH 2.6x8mm	
60	66-140230180121	SELF-TAPPING SCREW RoHS TA/BH 3x8mm (BLACK)	
61	66-140230210121	SELF-TAPPING SCREW RoHS TA/BH 3x10mm (BLACK)	
62	66-140230210321	SELF-TAPPING SCREW RoHS TA/BH 3x10mm	
63	66-140230212121	SELF-TAPPING SCREW RoHS TA/BH 3x12mm(BLACK)	
64	66-140230214121	SELF-TAPPING SCREW RoHS TA/BH 3x14mm(BLACK)	
65	66-140230214321	SELF-TAPPING SCREW RoHS TA/BH 3x14mm	
66	66-140330180321	SELF-TAPPING SCREW RoHS TA/PH 3x8mm	
67	66-140330210321	SELF-TAPPING SCREW RoHS TA/PH 3x10mm	
68	66-140530180121	SELF-TAPPING SCREW RoHS TA/KH 3x8mm(BLACK)	
69	66-140830210321	SELF-TAPPING SCREW RoHS TA/WH 3x10mm	
70	66-141430210321	SCREW RoHS TA/WH 3x10mm(HEAD:10mm)	
71	66-150330160321	SELF-TAPPING SCREW RoHS TB/PH 3x6mm	
72	66-150830180121	SELF-TAPPING SCREW RoHS TB/WH 3x8mm(BLACK)	
73	66-170230160103	HARDEN SCREW RoHS STTB 3x6mm AB(BLACK) RoHS	
74	67-021300000120	NUT+WASHER DIA M3mm	
75	67-021400000020	NUT M4mm	
76	68-112403101000	METAL WASHER 4x10x1mm	
77	68-412400000000	RING E TYPE 4mm	
78	06-200GF3501001	CD MECH ASSY, CRD-RA2A (205010)	
79	△ 18-201GF3500120	H/TRANSFORMER EI66 100V TJ61193F0 [JPN]	
	△ 18-203GF3500120	H/TRANSFORMER EI66 120V TU61153F0 [USA]	
80	190021093100220	SPEAKER 3" 10W 4Ω #JHD-SA78-25	
81	20-60ST15000000	PHONOGRAPH MECHANISM #H10B (HANPIN)	
	Ⓛ 58-43GF35000020	BELT, PHONOGRAPH MECH	9A10630600
82	△ 41-193220000220	POWER SWITCH (WELLLONG) SP3-22SPA-W4CZ	
83	43-500000002020	AC CORD BUSHING T=1.6mm #4N4	
84	05-GF4500100000	PCBA-MAIN -JAPAN "GF450-K7" [JPN]	
	05-GF4500100010	PCBA-MAIN -UL "GF450-K7" [USA]	
85	05-GF4500400000	PCBA-DIS-JAPAN "GF450-K7"	
86		PCBA-HP UL.....	Included in Ref. No. 84 PCBA-MAIN, refer to page 12
87		PCBA-AUX UL.....	Included in Ref. No. 84 PCBA-MAIN, refer to page 12
88	56-07GF4501B010	PUSH KNOB BRAOKET (ABS) [JPN]	
	56-07GF4501B020	PUSH KNOB BRAOKET (ABS) [USA]	
89	56-55GF4500B000	CASSETTE KNOB (ABS) SP572#931289	
90	61-11SCD6600020	REC. PCB BRACKET (1.0mm THK)	
91	20-06GF35000020	F/CASS DECK JS-21FB8947-SGS "GF450-K7"	
92	05-GF4502000000	PCBA-CASS -JAPAN "GF450-K7"	
93	56-01GF35000020	45 RPM ADAPTER (100-S300-069)	
94	△ 45-113420300150	AC CORD UL APP L=420mm 105C BLK	
95	41-142210010820	SWITCH SSE-22F10-G8-NS/SS-22F10-G8.....	included in Ref. No. 92 PCBA-CASS, refer to page 17
96		LED PCB	included in Ref. No. 85 PCBA-DIS, refer to page 14

EXPLODED VIEW

REF. NO.	PARTS NO.	DESCRIPTION	REMARKS
97	66-120230216121	MACHINE SCREW RoHS MS/BH 3x16mm (BLACK)	
98	66-140230180321	SELF-TAPPING SCREW RoHS TA/BH 3x8mm	
99	66-180230235121	SCREW RoHS TC/BH 3x35mm	
100	66-140326180321	SELF-TAPPING SCREW RoHS TA/PH 2.6x8mm	
101	66-140530210121	SELF-TAPPING SCREW RoHS TA/KH 3x10mm (BLACK)	
102	66-140826210321	SELF-TAPPING SCREW TA/WH 2.6x10mm	
103	66-170220130321	HARDEN SCREW RoHS TT/BH 2x3mm	
104	66-140330212121	SELF-TAPPING SCREW RoHS TA/PH 3x12 (BLACK)	
105	56-07GF4500B010	CASSETTE HOLDER (ABS) [JPN]	
	56-07GF4500B020	CASSETTE HOLDER (ABS) [USA]	

GF-450K7

5 PC BOARDS AND PARTS LIST

MAIN PCB

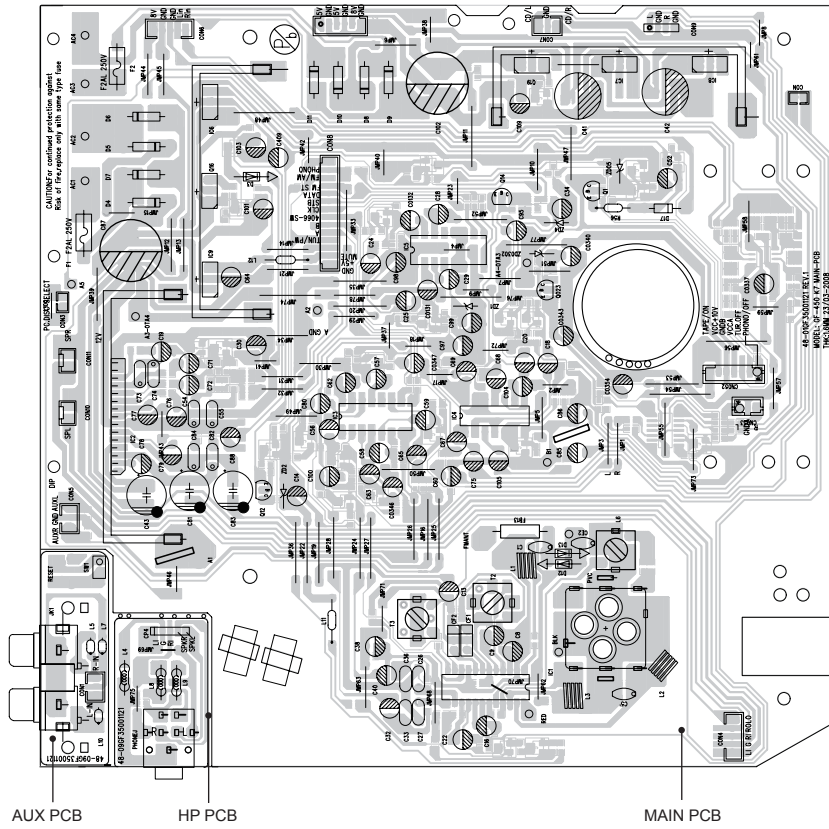

AUX PCB

HP PCB

MAIN PCB

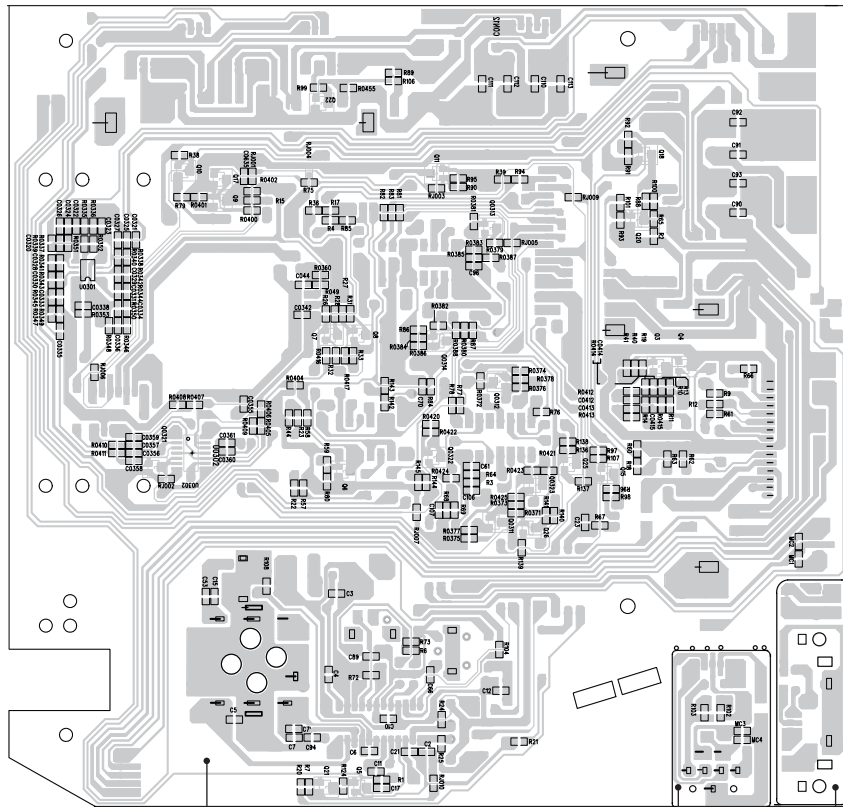

MAIN PCB

HP PCB

AUX PCB

MAIN PCB ASSY

REF. NO.	PARTS NO.	DESCRIPTION	REMARKS
C41,42 C43,81,83	05-GF4500100000	PCBA-MAIN -JAPAN "GF450-K7" [JPN]	
	05-GF4500100010	PCBA-MAIN -UL "GF450-K7" [USA]	
	48-01GF35001121	MAIN PCB 94V0 "GF450-K7"	
	26-017220760121	E.CAP 2200UF 16V +-80% -20% 105C	
	26-017100750121	E.CAP 1000UF 16V +-20% 105C	
C87,102	26-017470850121	E.CAP 4700UF 25V +-20% 85C	
CF1	31-026455000120	CERAMIC FILTER KTP455Y	
CF2	31-028107000110	CERAMIC FILTER SFE10.7MA5-A(3PIN)RED	
CON,3	43-012200120120	WAFER 2mm 2P 180C	
CON4	43-012200150120	WAFER 2mm 5P 180C	
CON5,053	43-012200130120	WAFER 2mm 3P 180C	
CON6	44-566320055620	5P SHIELDx2C/WIREx2 L=200mm HSG+TML(2.5)	J006
CON7	44-515290053520	3P WIRE L=90mm TML+HSG(2) (UL1007#26)	J003
CON52	43-012200170120	WAFER 2mm 7P 180C	
CON8	43-012200214120	WAFER 2mm 14P 180C	
CON9	44-515290054520	4P WIRE L=90mm TML+HSG(2) (UL1007#26)	J004
CON10,11	43-012250120120	WAFER 2.5mm 2P 180C	
CON12	44-515319056520	6P WIRE L=190mm HSG+TML(2) (UL1007#26)	J005
D3,12,13	12-1N4148000125	DIODE 1N4148 (T=52mm)	
D4,5,6,7,8,9,10,11	△ 12-1N5401000021	RECTIFIER DIODE 1N5401 3A 100V	
D17	△ 12-1N40010000P1	RECTIFIER DIODE 1N4001 (T=52mm)	
F1,2	△ 46-015200300010	AXIAL FUSE 4x10mm W/LEAD 2A/250V	
FB13	32-031351600025	FERRITE BEAD 3.5x6x0.8TB (TAPING)	
L001	40-213120215120	AM COIL (AD)/M3 120:15T 100mmx4	
L1	40-351550135020	FM COIL 5.5x3.5T (0.8mm)	
L2,3	40-351550145020	FM COIL 5.5x4.5T (0.8mm)	
L4,8,9	38-013100050120	AXIAL INDUCTOR 10UH +-10% 350mA EC-24	
L6	40-019100002020	I.F.T 10mm 910 (RED)	
L5,7,10	38-013100050120	AXIAL INDUCTOR 10UH +-10% 350mA EC-24	
L11,12	38-013100050120	AXIAL INDUCTOR 10UH +-10% 350mA EC-24	
IC1	16-SA2111000021	IC (SILAN) SA2111N	
IC2	16-BA5417000021	IC (ROHM) BA5417	
IC3	16-TC4052BP0021	IC (TOSHIBA) TC4052BP (DIP)	
IC4	16-HEF4066B0121	IC (PHILIPS) HEF4066BP	
IC5	16-TC9260P00021	IC (TOSHIBA) TC9260PAG	
IC7,9	16-KA7805000121	IC (SAMSUNG) KA7805E (TO-220)	
IC6,8	16-KA7808000221	IC (SAMSUNG) KA7808E (TO-220)	
U0301	16-BA4558F00021	IC (ROHM) BA4558F SOP8	
U0302	16-HEF4066B0021	IC (PHILIPS) HEF4066BT(D)(SOT108-1)	
PVC	27-010000130120	P.V.C (TOMY) #443DF-1DF (A/F) H15mm	
Q1,23	11-8050C0000025	TRANSISTORS 2W 8050C (TAPING)	
Q3,4,6,7,8,9,11,15,	11-MMBT39040221	SMD TRANSISTORS MMBT3904 SOT23	Ref. No. Continues: Q18,20~22,25,26, Q311~314,Q321~323
Q5	11-DTA124EK0021	SMD TRANSISTORS DTA124EKA-T146 (ROHM)	
Q10	11-MMBT85500021	SMD TRANSISTORS MMBT8550D (SOT23)	
Q12	11-8550D0000025	TRANSISTORS 2W 8550D (TAPING)	
Q14	11-9013G0000021	NPN TRANSISTORS 9013G 1W	
Q16,19	11-KSB772YS0021	TRANSISTORS KSB772YS (SAMSUNG)	
T2	40-01A049004020	I.F.T 10mm A049 (YELLOW)	
T3	40-017400003020	I.F.T 10mm 740 (ORANGE) (#7A40DZ)	
ZD1	12-011390320125	ZENER DIODE +-5% 3.9V 1/2W (T=52mm)	
ZD2	12-011430320125	ZENER DIODE +-5% 4.3V 1/2W (T=52mm)	
ZD4	12-011620320125	ZENER DIODE +-5% 6.2V 1/2W (T=52mm)	
ZD0302	12-012100320125	ZENER DIODE +-5% 10V 1/2W (T=52mm)	
ZD05	12-012120320125	ZENER DIODE +-5% 12V 1/2W (T=52mm)	
0101	32-022102700020	FERRITE BAR 10x70mm	
0102	32-042162120020	FERRITE CORE 16x12mm H=8mm	
J001	48-09GF35001120	AUX PCB 94V0	
J002	43-451200001020	RCA JACK 2P (R/W) PJB-12V01	
J002	44-365342053620	3P SHIELD WIRE L=420mm HSG(2)	
L4,8,9	48-09GF35000120	HP PCB 94V0	
J001	38-013100050120	AXIAL INDUCTOR 10UH +-10% 350mA EC-24	
J001	43-431360006020	PH 3.6mm JY353507001/PJ322A/HTJ03513AB	
CP4	44-515290055520	5P WIRE L=90mm TML+HSG(2) (UL1007#26)	

GF-450K7

DISPLAY PCB

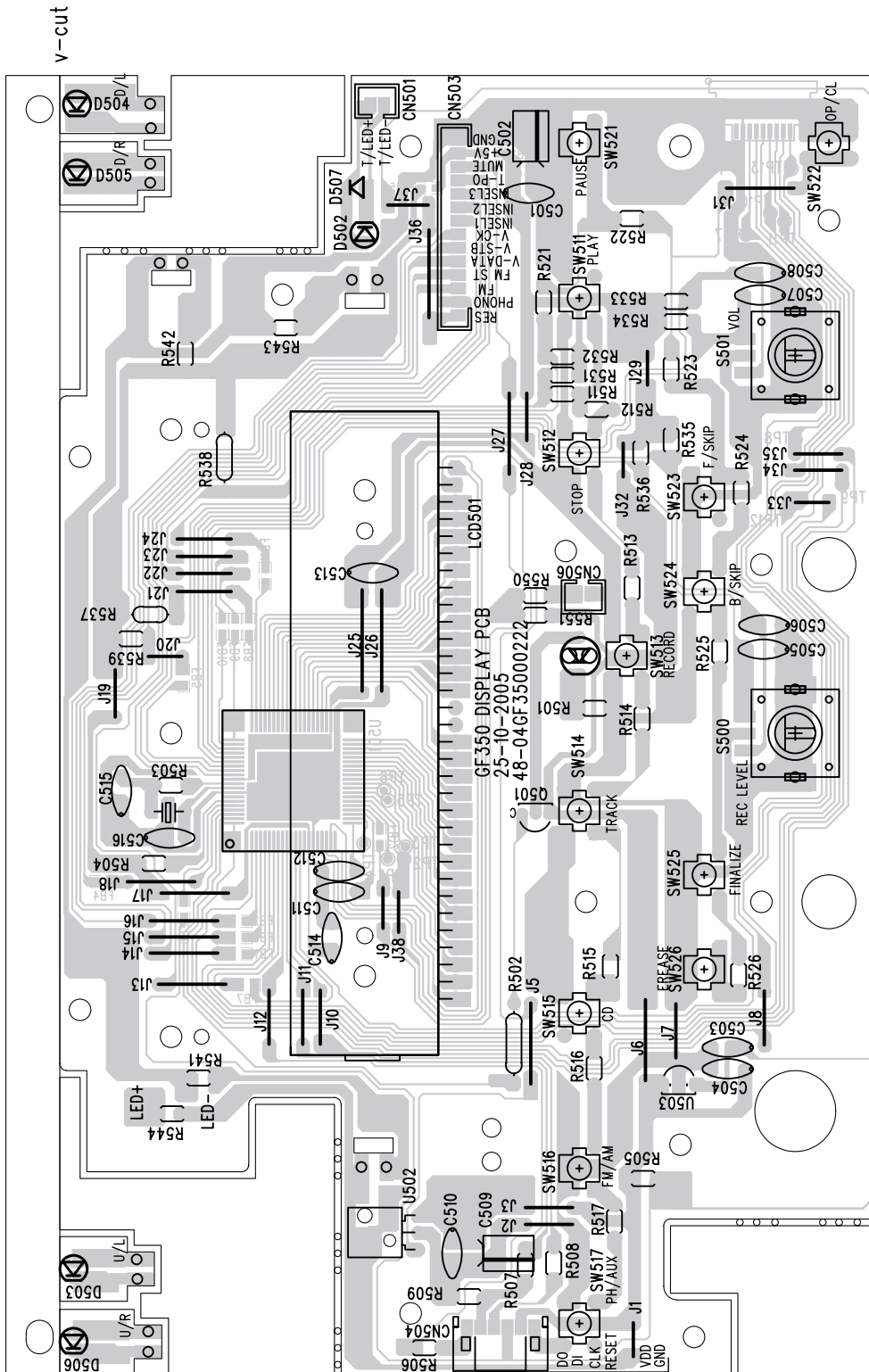

DISPLAY PCB ASSY

REF. NO.	PARTS NO.	DESCRIPTION	REMARKS
	05-GF4500400000	PCBA-DIS-JAPAN "GF450-K7"	
	48-04GF35000223	DISPLAY PCB 94HB	
	13-05GF35000120	LCD DISPLAY SDT-DA1746-TP-1	
CN501	44-315312052620	2P WIRE L=120mm HSG(2)x1 (UL1571#28)	J002
CN502	43-012100190530	SMD FFC.WAFER 1MM 9P 90C W/LOCK (BY CEC)	
CN503	44-515325064520	14P WIRE L=250mm TML+HSG(2) (UL1007#26)	J003
CN504	43-022200160120	WAFER 2mm 6P 90C	
CN506	44-515340052520	2P WIRE L=400mm TML+HSG(2) (UL1571#26)	J004
D502	13-011306622020	LED LAMP 3mm (BLUE) LA304B2MA-2C-05	
D507	12-1N4148000021	DIODE 1N4148	
D508	13-011292121020	LED LAMP (MICRO) MSC32D-C 2.94mm (RED)	
FB1,2,3,4,5,6,7,8,9,	32-03M352000120	SMD FERRITE BEAD 800Ω +-25% (1608)	
FB10,11,12,15,16			
Q501	11-DTA124ES0025	TRANSISTORS DTA124ES (ROHM) (TAPING)	
S500,501	22-501200000820	ROTARY ENCODER E1211A3AV1NG0000	
SW511,512,513,514,	41-150010030020	TACT SWITCH 6x6mm 5mm (160g+-30g) 4LEGS	
SW515,516,517,521,			
SW522,523,524,525,			
SW526			
U501	16-LC877C32C021	IC (SANYO) LC877C32C-57A7	
U502	17-05FM60380011	OPTIC SENSER (OPTO..) FM-6038TM2-5A	
U503	16-PST600D00021	IC (MITSUMI) PST600D	
X501	31-047450000020	CERAMIC RESONATOR 4.5MHZ	
		LED PCB	
D503,504,505,506	13-011200022020	LED LAMP 2x5x7mm (WHITE) MT-513UWC/W120	

GF-450K7

CASS PCB

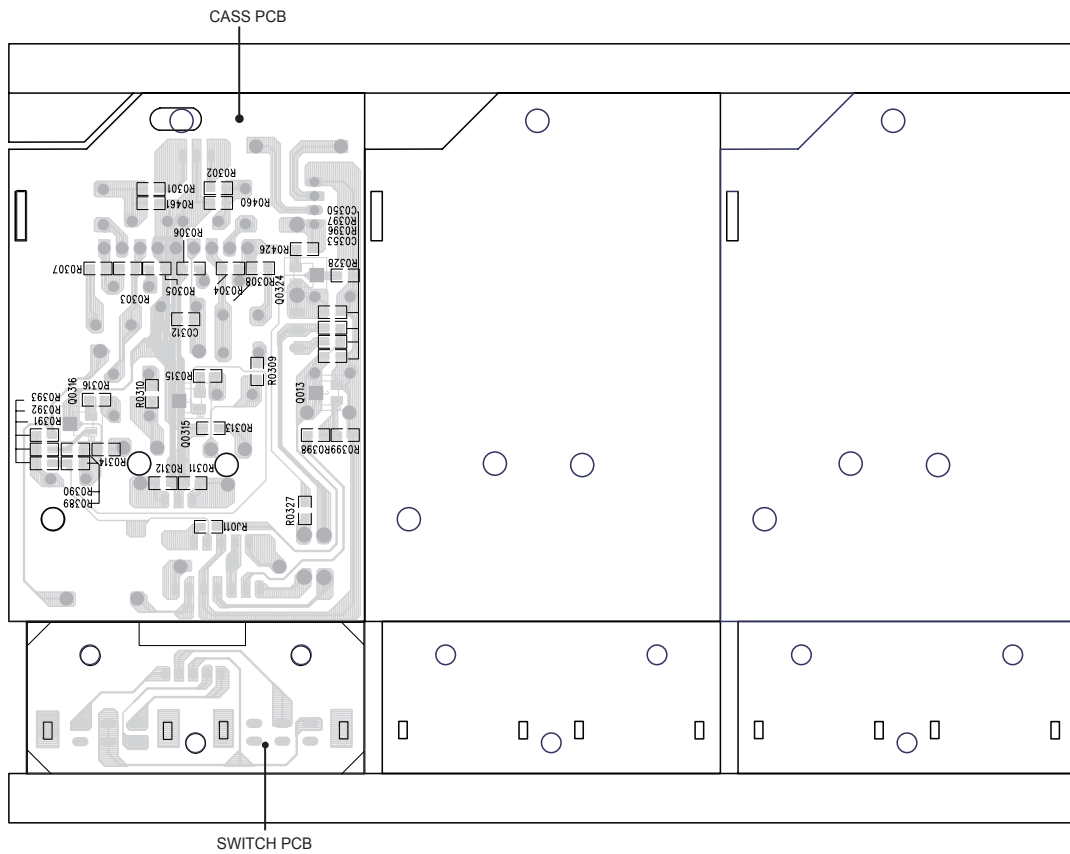
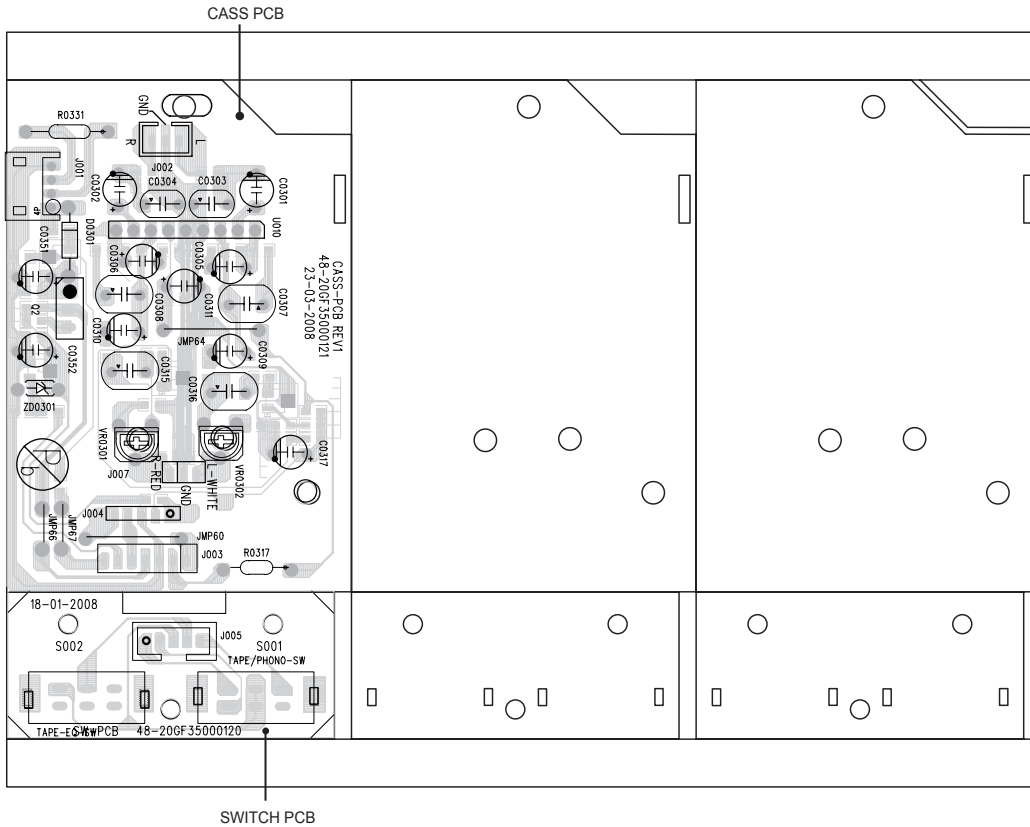

CASS PCB ASSY

REF. NO.	PARTS NO.	DESCRIPTION	REMARKS
	05-GF4502000000	PCBA-CASS -JAPAN "GF450-K7"	
	48-20GF35000121	CASS PCB 94V0 110x50x1.6mm "GF450-K7"	
D0301	12-1N4001000021	RECTIFIER DIODE 1N4001 1A 50V	
J002	43-012200130120	WAFER 2mm 3P 180C	
J001	43-022200140120	WAFER 2mm 4P 90C	
J007	44-365325053620	3P SHIELD WIRE L=250mm HSG(2)x1	
J004	44-315315055520	5P WIRE L=150mm HSG(2)x1 (UL1007#26)	
J003	44-315325057520	7P WIRE L=250mm HSG(2)x1 (UL1007#26)	
Q2	11-2SD882P000P1	TRANSISTORS 2SD882P	
Q0324	11-MMBT85500021	SMD TRANSISTORS MMBT8550D (SOT23)	
Q013,0315,0316	11-MMBT39040221	SMD TRANSISTORS MMBT3904 SOT23	
U010	16-LS2224100021	IC (RPF) LS22241	
VR0301,0302	22-800064500020	SEMI-FIXED 6mm 5K	
ZD0301	12-012120320125	ZENER DIODE +-5% 12V 1/2W (T=52mm)	
	48-20GF35000120	SW PCB 94V0	
J005	43-022200150120	WAFER 2mm 5P 90C (42369763700)	
S001,002	41-142210010820	SWITCH SSE-22F10-G8-NS/SS-22F10-G8	

GF-450K7

6 WIRING DIAGRAM

MAIN PCB

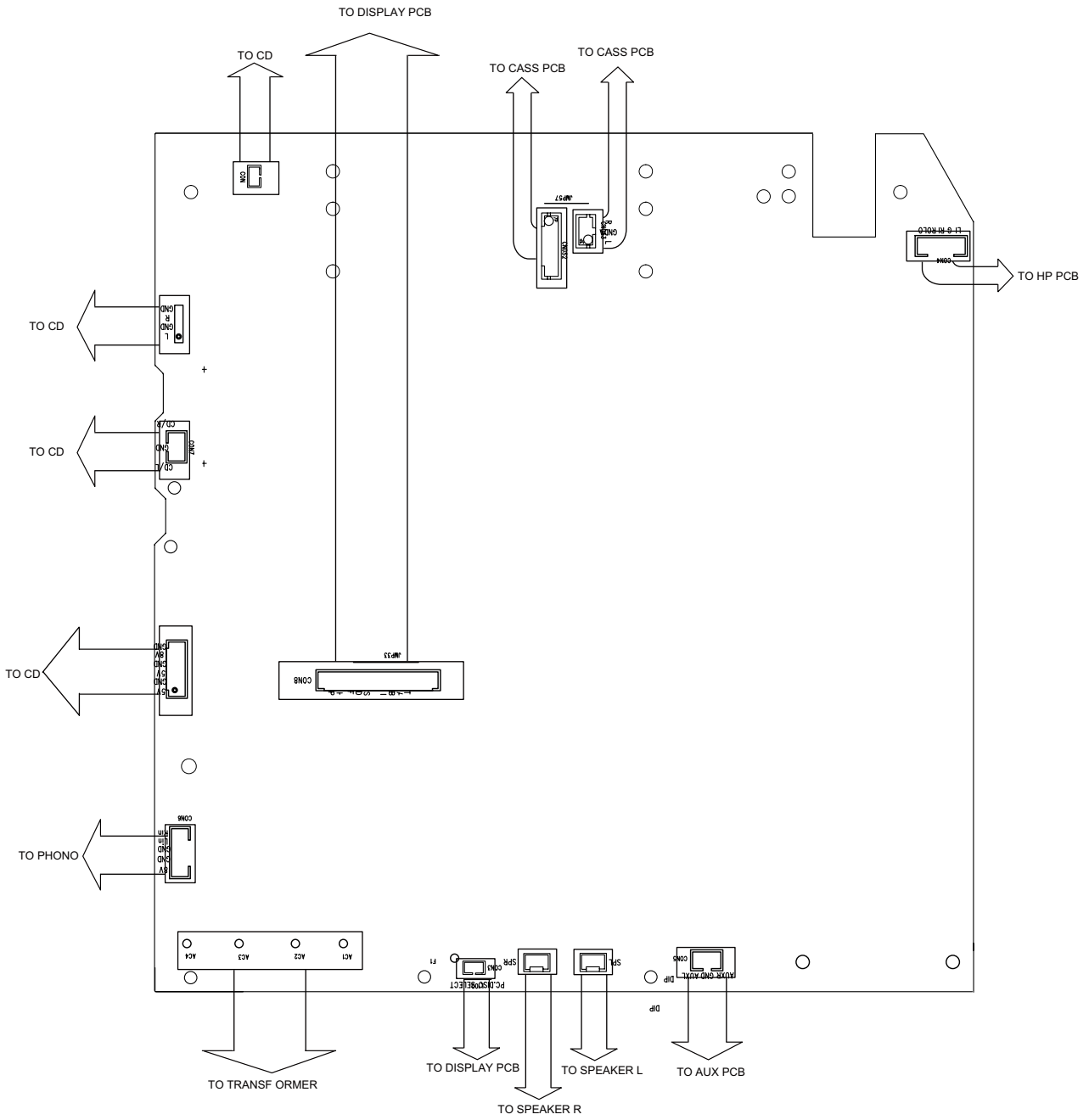

CASS PCB

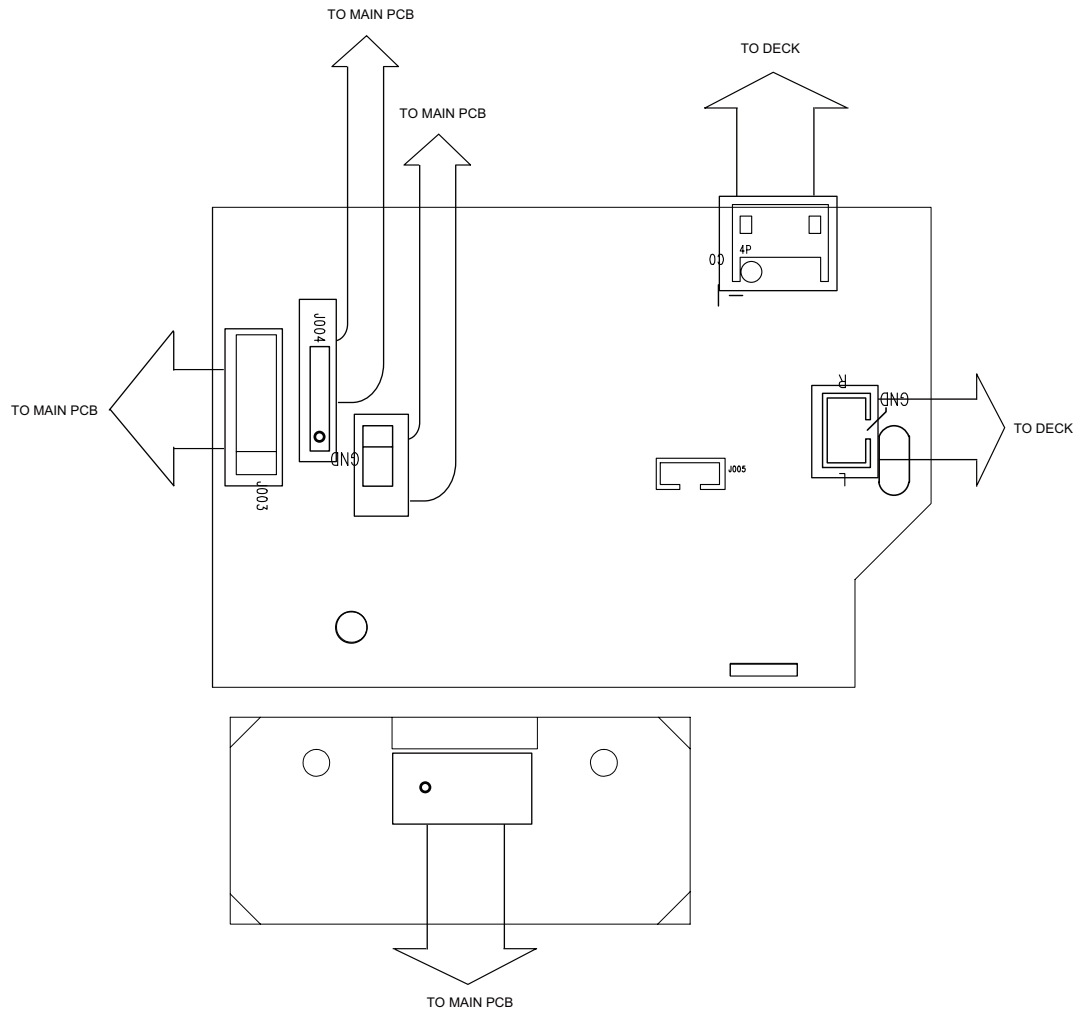

GF-450K7

DISPLAY PCB

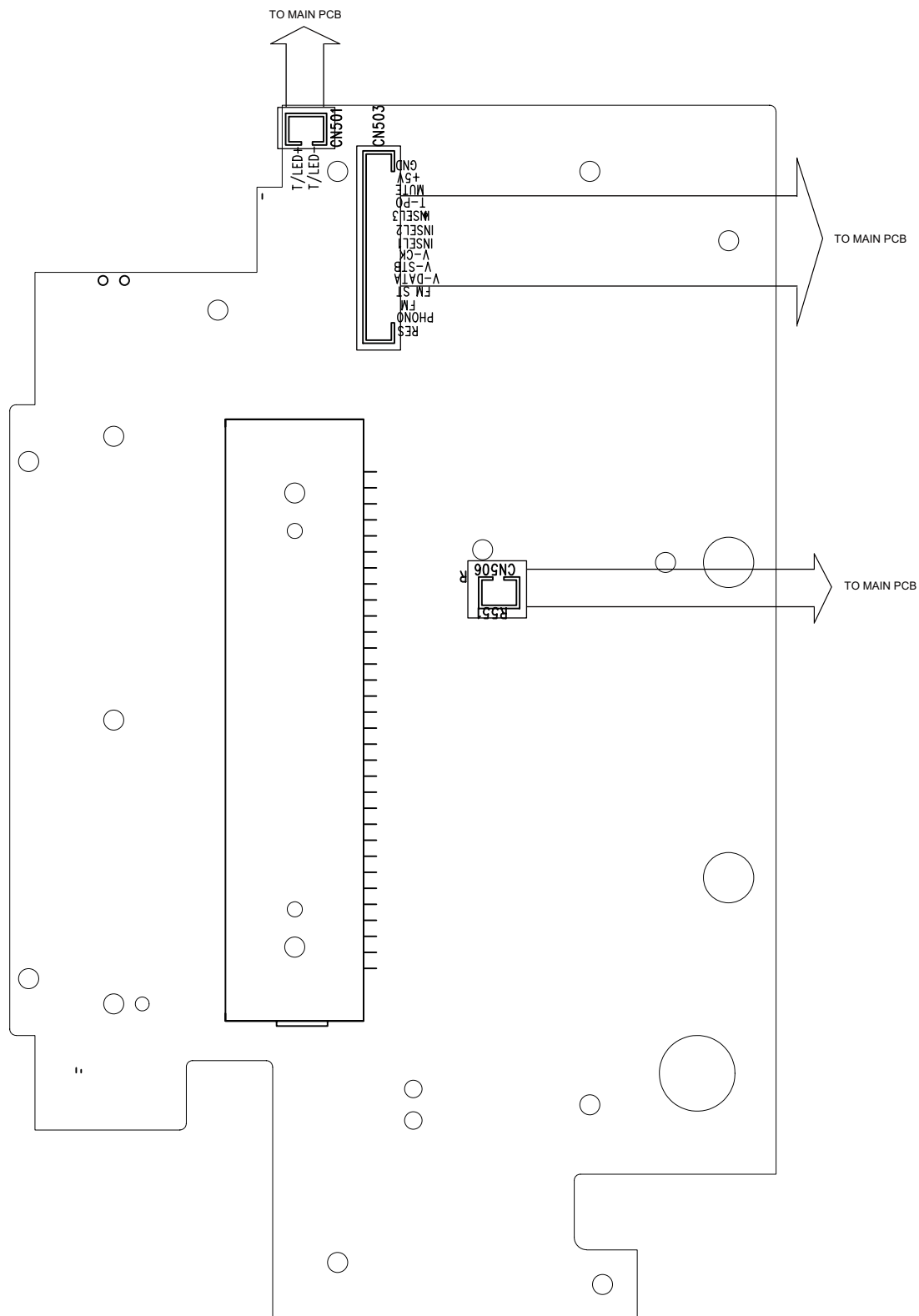

7 INCLUDED ACCESSORIES

INCLUDED ACCESSORIES

PARTS NO.	DESCRIPTION	REMARKS
02-170GF4501700	REMOTE CONTROL RC-992 [USA]	
02-170GF3501100	REMOTE CONTROL RC-1069 [JPN]	
51-011150300010	BATTERY 1.5V AA/UM-3x2	
77-20GF35000621	INSTRUCTION MANUAL "GF450-K7" [JPN]	
77-20GF45000021	INSTRUCTION MANUAL (UL) (E/F/S) [USA]	
77-21GF35000620	INSTRUCTION SHEET "GF450-K7" [JPN]	
77-21GF45000021	INSTRUCTION SHEET (UL) (E/F/S) [USA]	
77-23ST15000121	PHONOGRAPH TRAY CARD #R10 R3 [JPN]	
77-23ST15000023	PHONOGRAPH TRAY CARD #R10 R3 [USA]	
45-203840005220	RCA PLUG CORD 2P L=840MM (R/W) (BLK)	

GF-450K7

TEAC

SKTE-SM0807002

TEAC CORPORATION	1-47, Ochiai, Tama-shi, Tokyo 206-8530, Japan Phone: (042) 356-9155
TEAC AMERICA, INC.	7733 Telegraph Road, Montebello, California 90640 Phone: (323) 726-0303
TEAC CANADA LTD.	5939 Wallace Street, Mississauga, Ontario L4Z 1Z8, Canada Phone: (905) 890-8008
TEAC MEXICO, S.A. De C.V	Río Churubusco 364, Colonia Del Carmen, Delegación Coyoacán, CP 04100, México DF, México Phone:(5255)5010-6000
TEAC UK LIMITED	Unit 19 & 20, The Courtyards, Hatters Lane, Watford, Hertfordshire, WD18 8TE, U.K. Phone: (0845) 130-2511
TEAC EUROPE GmbH	Bahnstrasse 12, 65205 Wiesbaden-Erbenheim, Germany Phone: 0611-71580

JULY 2008

PREPARED IN CHINA

MAIN PCB

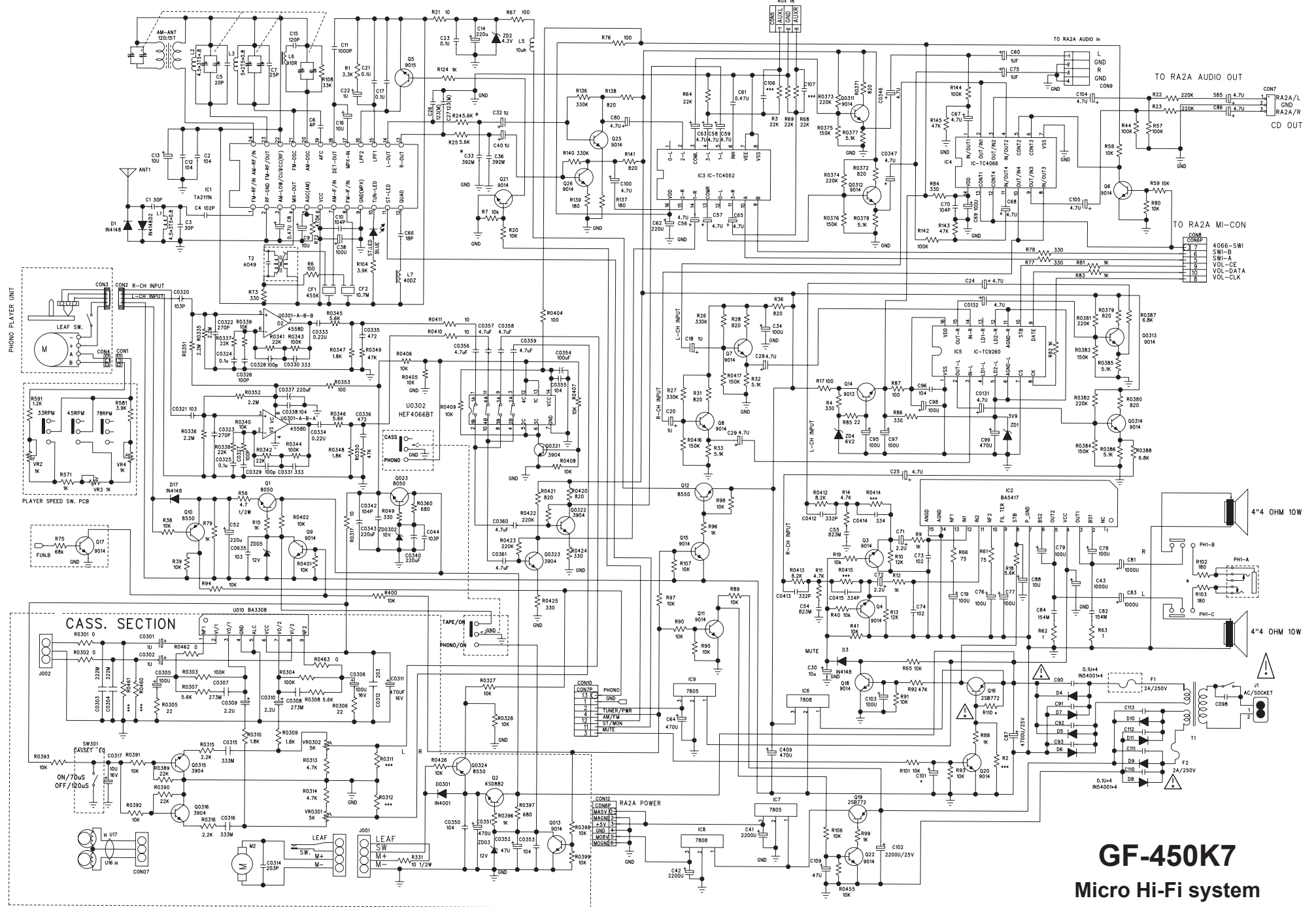

GF-450K7
Micro Hi-Fi system

DISPLAY PCB

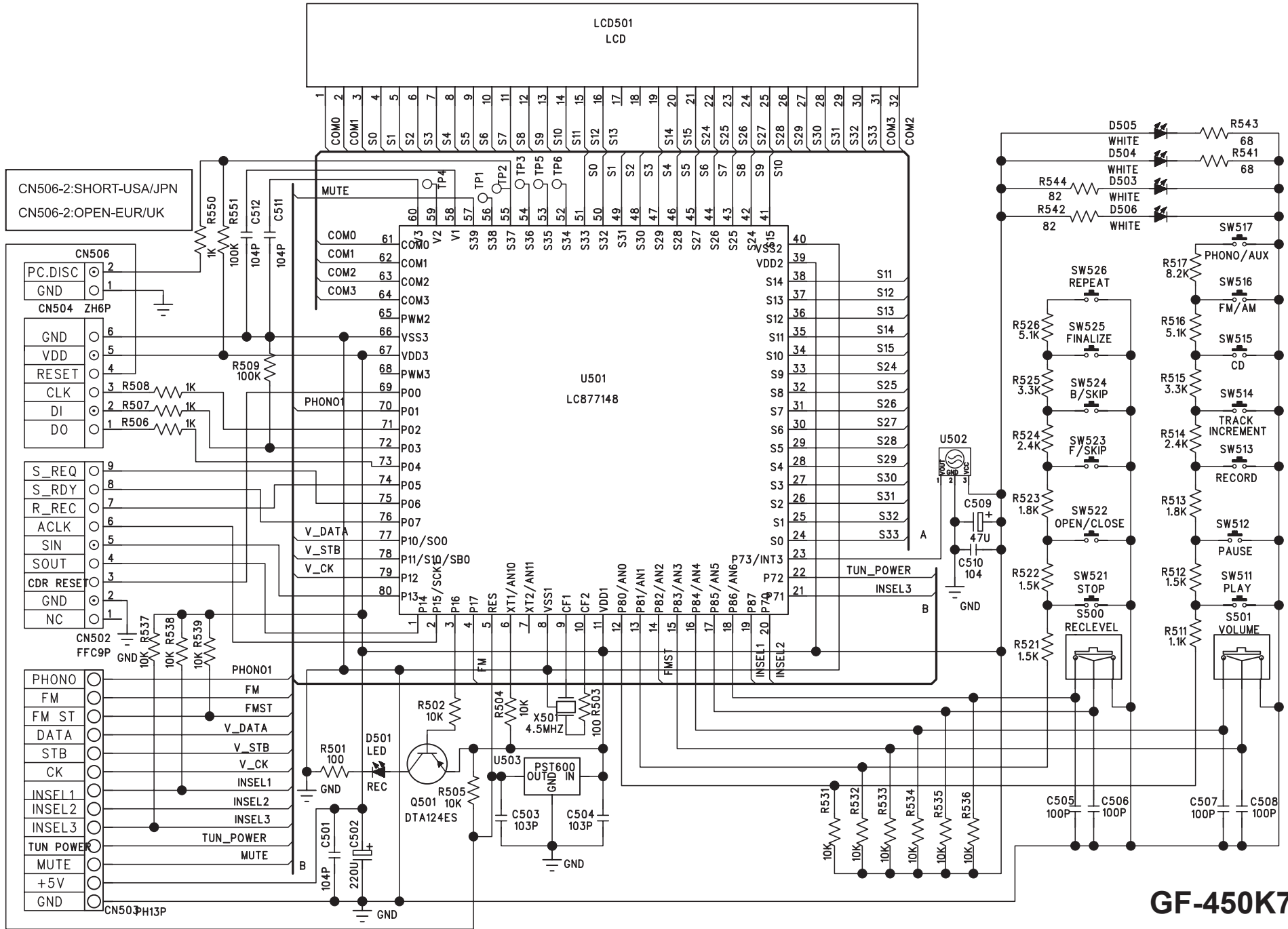

GF-450K7
Micro Hi-Fi system

